



PL400
Patient Lift Scale Indicator
Owner's Manual



8551-M912-01 Rev D
08/14

CARDINAL SCALE MFG. CO.
PO BOX 151 WEBB CITY, MO 64870
PH (417) 673-4631 - FAX (417) 673-5001
www.cardinalscales.com

Printed in USA

Technical Support: Ph: 866-254-8261 • techsupport@cardet.com

INTRODUCTION

Thank you for purchasing our DETECTO™ Model PL400 Patient Lift Scale Indicator. It has been manufactured with quality and reliability at our factory in Webb City, MO USA. This instrument has been tested before leaving our factory to insure accuracy and dependability for years to come.

This manual is provided to guide you through installation, operation and maintenance of your indicator. Please read it thoroughly before attempting to install or operate your PL400 and keep it handy for future reference.

FCC COMPLIANCE STATEMENT

This equipment generates uses and can radiate radio frequency and if not installed and used in accordance with the instruction manual, may cause interference to radio communications. It has been tested and found to comply with the limits for a Class A computing device pursuant to Subpart J of Part 15 of FCC rules, which are designed to provide reasonable protection against such interference when operated in a commercial environment. Operation of this equipment in a residential area may cause interference in which case the user will be responsible to take whatever measures necessary to correct the interference.

You may find the booklet "How to Identify and Resolve Radio TV Interference Problems" prepared by the Federal Communications Commission helpful. It is available from the U.S. Government Printing Office, Washington, D.C. 20402, stock No. 001-000-00315-4.

All rights reserved. Reproduction or use, without expressed written permission, of editorial or pictorial content, in any manner, is prohibited. No patent liability is assumed with respect to the use of the information contained herein. While every precaution has been taken in the preparation of this manual, the Seller assumes no responsibility for errors or omissions. Neither is any liability assumed for damages resulting from use of the information contained herein. All instructions and diagrams have been checked for accuracy and ease of application; however, success and safety in working with tools depend to a great extent upon the individual accuracy, skill and caution. For this reason the Seller is not able to guarantee the result of any procedure contained herein. Nor can they assume responsibility for any damage to property or injury to persons occasioned from the procedures. Persons engaging the procedures do so entirely at their own risk.

TABLE OF CONTENTS

Introduction	1
Specifications	1
European Declaration Of Conformity	2
Installation	3
Battery Replacement	3
Keypad Functions	4
Operation	4
Lock Weight Feature	4
Automatic Shut-Off Feature	5
Display Codes	5
Annunciators	5
Setup and Calibration	6
Part Identification	7

SPECIFICATIONS

Capacity:	400 lbs (180 kg)
Resolution:	0.2 lb (0.1kg)
Display:	LCD digital display
Power Requirements:	9.0 V Battery (<i>included</i>)
Temperature Range:	50° to 104° F (+10° to +40° C)
Overall Dimensions:	4.13" W x 2.13" D x 5.0" D (10.5cm x 5.4cm x 12.7cm)
Mounting Hole Spacing:	4" (10.16cm) Center to Center
Shipping Weight:	2 lbs (0.91kg)

SERIAL NUMBER _____
DATE OF PURCHASE _____
PURCHASED FROM _____

RETAIN THIS INFORMATION FOR FUTURE USE

<p align="center">PRECAUTIONS</p> <p>Before using this instrument, read this manual and pay special attention to all "NOTIFICATION" symbols:</p> <p align="center"> IMPORTANT</p>
--

EUROPEAN DECLARATION OF CONFORMITY

Manufacturer: Cardinal Scale Manufacturing Company
PO Box 151
203 East Daugherty
Webb City, Missouri 64870 USA

Telephone No. (417) 673-4631
Fax No. (417) 673-5001

Product: Non-automatic Weight Indicating Instrument / Load Receiver
Model Number PL400 / PL600
Serial Number EXXXYY-ZZZ
where XXX = day of year
YY = last two digits of year
ZZZ = sequential number

The undersigned hereby declares, on behalf of Cardinal Scale Manufacturing Company of Webb City, Missouri, that the above-referenced product, to which this declaration relates, is in conformity with the provisions of:

European Standard EN5022/1994 (CISPR22/1993) Electromagnetic Emissions

The Technical Construction File required by this Directive is maintained at the corporate headquarters of Cardinal Scale Manufacturing Company, 203 East Daugherty, Webb City, Missouri.

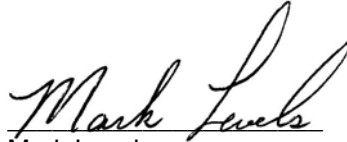

Mark Levels
Quality Assurance Administrator

INSTALLATION

The Detecto PL400 Patient Lift Scale Indicator is a completely self-contained, battery-powered instrument that is used to determine the weight of a person suspended from a portable patient lift mechanism. The PL400 consists of a weight indicator with an integral tension load cell and with its small size and simple, easy operation; it can be used where standard indicators are too large and cumbersome. Setup and Operation of the PL400 can be quickly learned using the following instructions and guidelines.

Before beginning installation of your PL400 Patient Lift Scale Indicator, make certain the instrument has been received in good condition. When removing the indicator from its packing, inspect it for signs of damage, such as exterior dents and scratches. Keep the carton and packing material for return shipment if it should become necessary. It is the responsibility of the purchaser to file all claims for any damages or loss incurred during transit.

1. Remove the instrument from the shipping carton and inspect it for any signs of damage that might have taken place during shipment such as exterior dents and scratches.
2. Install the battery. Refer to the BATTERY REPLACEMENT section for more instruction.
3. Place the indicator on the hook of the patient lift mechanism.
4. The indicator is now ready for use.

BATTERY REPLACEMENT

The PL400 uses a single 9 volt alkaline battery. The battery is contained in a battery holder inside the instrument. Access is via a removable panel on the back of the indicator.

To install the battery, turn the indicator so that the display is facing down (away from you) and resting on the keypad. Locate the rectangular panel on the back of the indicator and remove the thumbscrew retaining it (see Figure 1). Remove the panel exposing the battery holder. Install the 9 volt battery in the holder; making certain it is positioned in accordance with the polarity markings located in the battery holder. Refer to Figure No. 2 for illustration of battery installation.

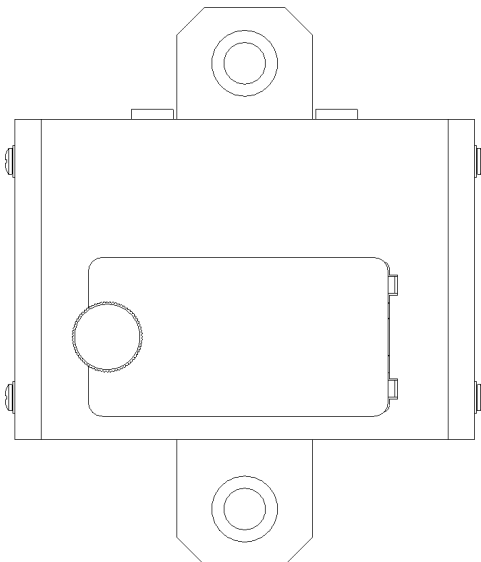

Figure No. 1

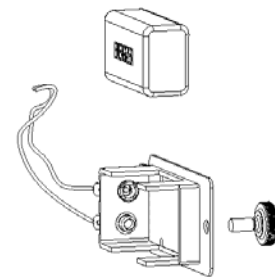

Figure No. 2

KEYPAD FUNCTIONS

The PL400 Patient Lift Scale Indicator has a membrane keypad containing three (3) keys. The keypad is shown in Figure No. 3. The following describes the use of each key:

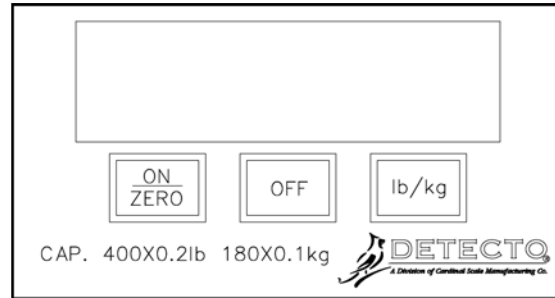
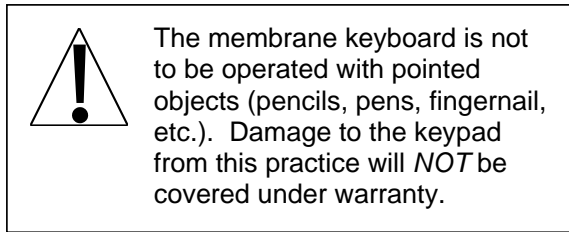

Figure No. 3



Pressing this key will apply power to the instrument and turn on the indicator display. If the indicator is already on, pressing this key will zero the indicator.



Pressing this key when the indicator is on will remove power to the instrument.



This key is used to change the weighing units to the alternate units of measurement. For example, with pounds displayed (lb annunciator turned on) pressing this key will change the weighing units to kilograms (kg annunciator will turn on).

OPERATION

1. Press the **ON/ZERO** key to turn the indicator on. If the LOCK feature has been enabled, the unit will display the last weight reading stored by the device and the LOCK annunciator will be on. Otherwise, the unit will display the current weight.
2. To clear the last weight reading stored, press the **ON/ZERO** key. The unit will then display the current weight.
3. Press the **ON/ZERO** key again to zero the display.
4. The patient is placed in the sling and lifted from the bed.
5. When weight is stable, the *STABLE* annunciator will turn on.
6. If the Auto-Shutoff feature has been enabled, the unit will turn itself off after a stable weight reading is displayed for the preset time. Refer to the **AUTOMATIC SHUT-OFF FEATURE** section for more information.
7. If the unit turns off before the patient was properly weighed, it can be turned on again by pressing the **ON/ZERO** key as described in steps 1 and 2.

LOCK WEIGHT FEATURE

This feature stores the last weight reading when the unit is turned off, either by the Auto-Shutoff feature or by pressing the **OFF** key. When enabled, after turning the unit back on, the stored weight is displayed and the LOCK annunciator will be lit to indicate the displayed weight is a stored weight and not the current weight. This feature allows the operator to store a weight reading and record it after leaving the patient's room.

The Lock Weight feature is enabled or disabled during the indicator Setup and Calibration. Refer to that section for more information.

AUTOMATIC SHUT-OFF FEATURE

The PL400 is equipped with an automatic shut-off feature that helps prolong battery life by turning the indicator off after a preset amount of time after a stable weight reading has been reached. To turn the indicator back on you must press the **ON/ZERO** key. The automatic shut-off feature is activated during the setup and calibration procedure and can be set to display weight for 10 to 90 seconds (*time approximate*) after a stable weight reading has been reached before the indicator will automatically shut off. The automatic shut-off feature may be disabled by selecting " 0 " during the Setup and Calibration. Refer to that section for more information.

DISPLAY CODES

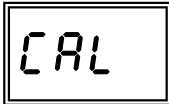

CALIBRATION REQUIRED - Indicates improper stored calibration data, calibration is necessary.

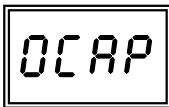

OVER CAPACITY - Indicates a weight exceeding the capacity of scale has been placed on the scale tray.

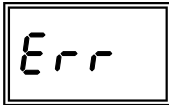

ERROR - NOV RAM test failure.

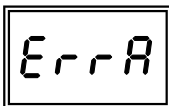

ANALOG FAILURE - This could mean a damaged or defective load cell or a failed component in the analog circuitry of the indicator.

ANNUNCIATORS

LO BAT

The *LO BAT* annunciator is turned on to indicate that the battery should be replaced.

ZERO

The *ZERO* annunciator is turned on to indicate that the weight is within +/- 1/4 division of the center of zero.

lb

The *lb* annunciator is turned on to indicate that the Weight mode and the weight displayed are in pounds.

kg

The *kg* annunciator is turned on to indicate that the Weight mode and the displayed weight are in kilograms.

LOCK

The *LOCK* annunciator is turned on to indicate that the weight displayed is a stored weight value and not the current weight.

STABLE

The *STABLE* annunciator is identified with two (2) ▷◁ small triangle shapes and is turned on to indicate the weight display is stable.

SETUP AND CALIBRATION

1. To begin Setup and Calibration, press the **ON/ZERO** key to turn the indicator on, then when the display is showing *r 1.2*, simultaneously press the **ON/ZERO** and the **lb/kg** keys.
2. The indicator will display *LAL*. Press the **ON/ZERO** key to select **0** = do not calibrate (allows you to setup the indicator without calibrating) or **1** = enter calibration, and then press the **lb/kg** key to save the setting.

If you select 0 = do not calibrate, then proceed to step 6.

If you select 1 = enter calibration, the indicator will display *L0Ad*.

3. Place 200 lb or 100 kg on the scale.
4. Press the **lb/kg** key. After taking four weight samples, the indicator will display *UnLd*.
5. Remove the weight from the scale and press the **lb/kg** key.
6. The indicator will display *UnIt*. Press the **ON/ZERO** key to step through the selections (0 through 3). When the desired value is displayed, press the **lb/kg** key to save the setting.

0 = Pounds/Kilograms - Calibrated in pounds and will default to pounds when turned on. The displayed weight may be switched to kilograms by pressing the lb/kg key.

1 = Kilograms/ Pounds - Calibrated in kilograms and will default to kilograms when turned on. The displayed weight may be switched to pounds by pressing the lb/kg key.

2 = Pounds Only - Calibrated in pounds and will only display pounds.

3 = Kilograms Only - Calibrated in kilograms and will only display kilograms.

7. The indicator will display *ASH*. This is the prompt for the Automatic Shutoff feature. This feature defines the amount of time a stable weight reading must be displayed before the PL400 will turn itself off. Press the **ON/ZERO** key to step through the selections (0 through 9) for the number of seconds the display will stay on after a stable weight reading before turning off. When the desired value is displayed, press the **lb/kg** key to save the setting.

0 = disable auto-shutoff feature

1 to 9 = approximately 10 seconds to 90 seconds

8. The indicator will display *L0L*. This is the prompt for the Lock Display mode. This mode of operation stores the displayed weight when the unit is turned off and will display that same weight the next time the unit is turned on. Press the **ON/ZERO** key to step through the selections, **0** to disable or **1** to enable. When the desired value is displayed, press the **lb/kg** key to save the setting.

With the display LOCK feature disabled (**0**), the indicator will not store the last displayed weight and will turn on displaying the current weight. With the display LOCK feature enabled (**1**), the indicator stores the displayed weight when the unit is turned off and will display that weight the next time the unit is turned on. The LOCK annunciator will be on to show that the weight displayed is a stored value and not the current weight.

9. The indicator will briefly display *dOnE*, and then reset to the Operation weight mode.



NOTE: The display will be *locked* if the display *L0L* feature has been enabled.

PARTS IDENTIFICATION

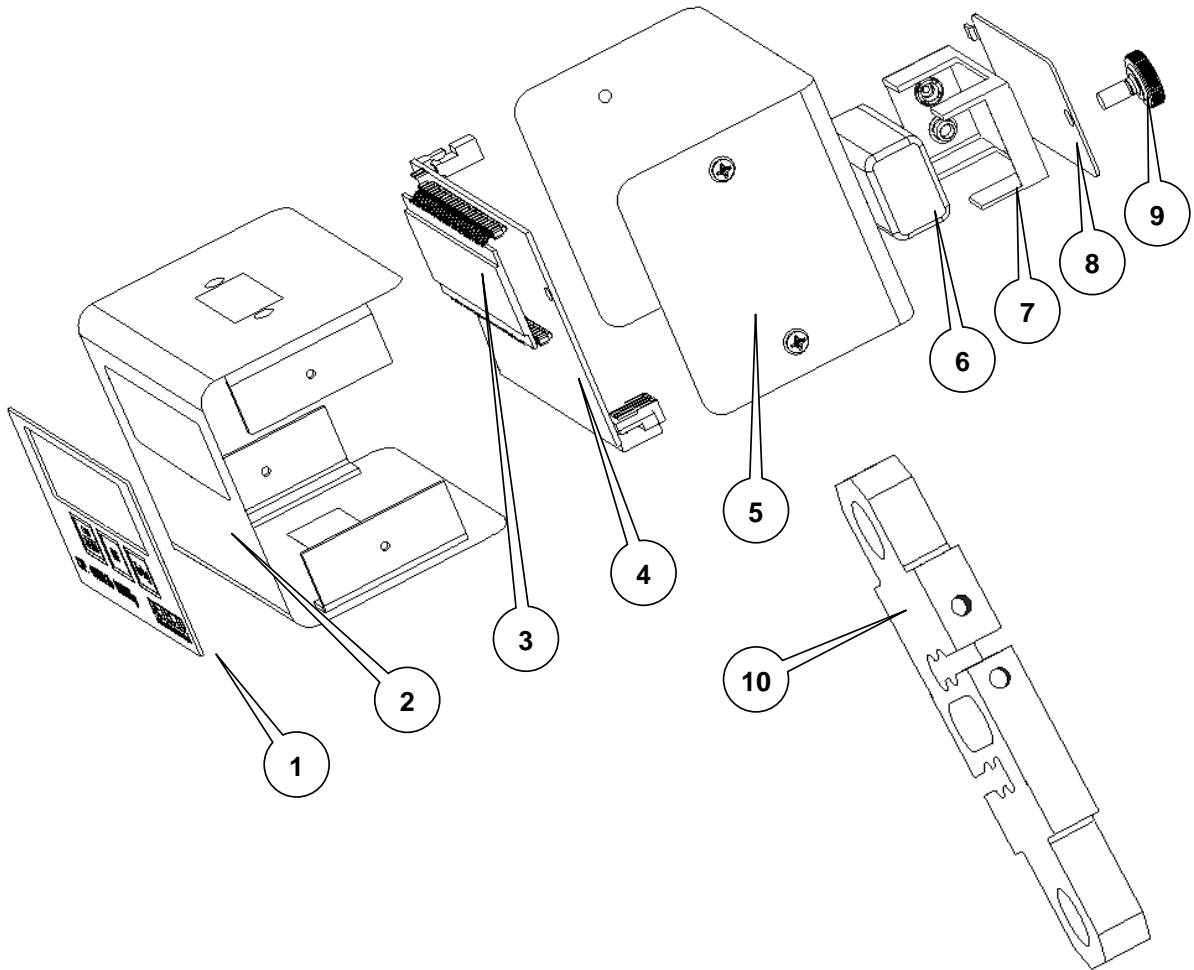

Item	Part No.	Description
1	8551-C901-08	PL400 KEYBOARD
2	8551-C905-0A	FRONT ENCLOSURE
3	8551-C902-08	LCD DISPLAY
4	8551-C900-0A	MAIN PCB ASSY
5	8551-C904-08	REAR ENCLOSURE
6	6800-1031	9V ALKALINE BATTERY
7	8551-B909-0A	BATTERY HOLDER ASSY
8	8551-B906-08	BATTERY COVER
9	8535-B025-08	THUMB SCREW
10	2920-C084-0A	ZPL500 LOAD CELL ASSY
not shown	850B-P1941	PL400 PROGRAMMED EPROM
not shown	6028-0018	LINK OVAL SPRING GATE 3/8 DIA, 4" LG, STEEL, QTY. 2

STATEMENT OF LIMITED WARRANTY

Detecto Scale warrants its equipment to be free from defects in material and workmanship as follows: Detecto warrants to the original purchaser only that it will repair or replace any part of equipment which is defective in material or workmanship for a period of one **(1) year** from date of shipment. Detecto shall be the sole judge of what constitutes a defect.

During the **first ninety (90) days** Detecto may choose to supply all necessary replacement parts and service during normal weekday working hours at no charge to the buyer.

After the first ninety (90) days Detecto will supply parts and service at the job site provided the owner agrees to pay the Dealer for all travel time, including mileage and test equipment, as well as any expenses incurred over the direct labor of the technician at the job site. This limited warranty honors only labor performed by Detecto authorized dealers.

This warranty does not apply to peripheral equipment not manufactured by Detecto; this equipment will be covered by certain manufacturer's warranty only.

This warranty does not include replacement of expendable or consumable parts. This does not apply to any item which has deteriorated or damaged due to wear, accident, misuse, abuse, improper line voltage, overloading, theft, lightning, fire, water or acts of God, or due to extended storage or exposure while in purchaser's possession. This warranty does not apply to maintenance service. Purchased parts will have a ninety (90) day repair or replacement warranty only.

Detecto may require components be returned to the factory; they must be properly packed and shipping charges prepaid. A return authorization number must be obtained for all returns and marked on the outside of all returned packages. Detecto accepts no responsibility for loss or damage in transit.

STATEMENT OF LIMITED WARRANTY

Conditions Which Void Limited Warranty

This warranty shall not apply to equipment which:

- A.) Has been tampered with, defaced, mishandled or have had repairs and modifications not authorized by Detecto.
- B.) Has had serial number altered, defaced, or removed.
- C.) Has not been grounded according to Detecto's recommended procedure.

Freight Carrier Damage

Claims for equipment damaged in transit must be referred to the freight carrier in accordance with freight carrier regulations.

This warranty sets forth the extent of our liability for breach of any warranty or deficiency in connection with the sale or use of the product. Detecto will not be liable for consequential damages of any nature, including but not limited to, loss of profit, delays or expenses, whether based on tort or contract. Detecto reserves the right to incorporate improvements in material and design without notice and is not obligated to incorporate improvements in equipment previously manufactured.

The foregoing is in lieu of all other warranties, express or implied including any warranty that extends beyond the description of the product including any warranty of merchantability or fitness for a particular purpose. This warranty covers only those Detecto products installed in the forty-eight (48) contiguous continental United States.



Ph. (800) 641-2008
E-mail: detecto@cardet.com
203 E. Daugherty
Webb City, MO 64870

02/06
Printed in USA
D268-WARRANTY-DET

