

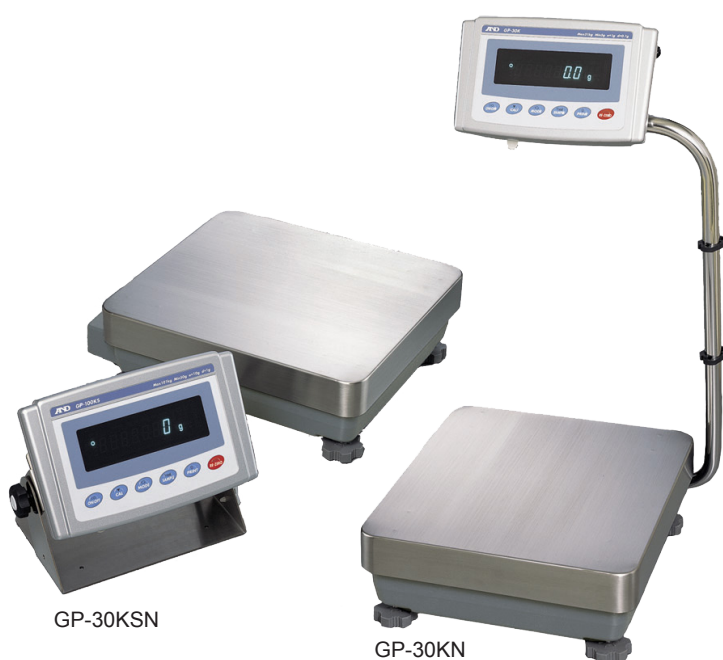





# IP65 dust and water protection meets NTEP Certified Accuracy



GP-30KSN

GP-30KN

## KEY FEATURES:

-  Super Hybrid Sensor
-  Internal Calibration
-  IP65
-  RS-232C Standard
-  GLP/GMP Compliant



NTEP Approved  
Class II  
CC# 21-003

## Advanced Sensor Technology

Innovative hybrid weighing technology enhances performance up to 31 kg capacity

- Decreases stabilization time for higher throughput
- Built-in overload protection improves durability
- Internal calibration with auto self checking automatically adjusts to changing environmental conditions guaranteeing consistent results

## Legal for Trade models

The A&D GP-30KN and GP-30KSN are Class II NTEP certified ensuring compliance for indirect sales in the United States

- All displayed values are  $e = 10d$  with a bracketed last digit
- Below weighing approved with GP-20 under-hook
- Includes sealing screws

## Practical Features

- IP65 rated for low pressure washdown environments, protects against dust, spills or loose granules
- Swing arm (KN models) or detachable display (KSN models) provides flexibility for bench top or floor applications
- Data Memory: 200 sets of weighing data, 100 sets of weighing data with time and date, 20 sets of tare values and 50 sets of GLP data
- GLP / GMP / ISO Compliant printouts ensure traceability and data integrity
- Standard RS232C includes WinCT software for easy system integration
- Durable aluminum construction with industry leading 5 year warranty

**Specifications**

**GP-30KN | GP-30KSN**

Capacity	31 kg / 68 lb
Verified scale division e	e = 1 g
Displayed scale division d (e = 10 d default)	d = 0.[1] g (only approved for indirect sale applications)
Repeatability	0.1 g
Linearity	0.2 g
Stabilization Time	1.5 seconds
Sensitivity Drift (10 °C to 30 °C)	3ppm °C
Operating Temperature	10 °C to 30 °C (50 °F to 86 °F)
Sensing Method	Super Hybrid Sensor (SHS)
Display Type	Vacuum Fluorescent Display (VFD)
Display Refresh Rates	5 times/second or 10 times/second
Weighing Units	g, kg, lb, oz
Standard Interface	RS-232C serial interface with Windows Communication Tools (WinCT)
Recommended External Calibration Weight	20 kg / 30 kg
Water & Dust Protection	IP65 for indicator and platform
Weighing Pan	Stainless steel 384 x 344 mm / 15.2 x 13.5 inch
Calibration	Motor-driven internal calibration mass
External Dimensions (WxDxH)	372 x 615 x 130 mm / 14.6 x 24.2 x 5.2 inch
Power Consumption	Approximately 14VA
Net Weight	17 kg / 37 lb
Options	GP-04: Comparator Output (relay with buzzer), RS-232C Current Loop, GP-06: Analog/Current Loop Output, GP-07: 5 meter indicator connection cable, GP-12: Animal Weighing pan, GP-20: Underhook, GP-22: AD-8121B Printer Support
Accessories	AX-KO1710-200: RS-232C Cable (25P-9P), AX-SW-128: Foot Switch, AD-1682: Rechargeable Battery Unit, AD-8526: Ethernet Converter, AD-8920A: Remote Display, AD-8922A: Remote Controller

**Dimensions** (mm)

Swing arm display type: GP-30KN

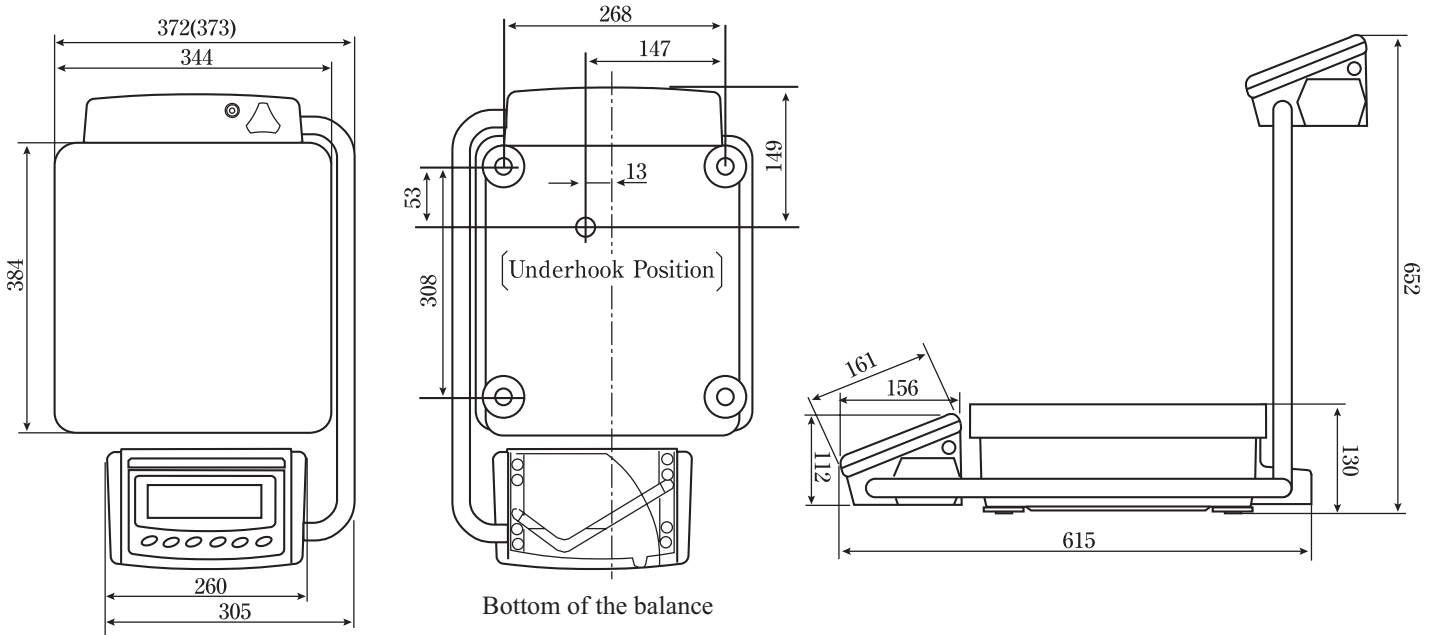

Detached Display type: GP-30KSN

