



**WBZ and WBZ..aM SERIES**  
**(with EC or NTEP type Approval)**  
(P.N. 9042, Rev. H, December 2010)

Software rev.: 2.22 and above



# CONTENTS

1.0	INTRODUCTION .....	3
2.0	SPECIFICATIONS.....	3
3.0	INSTALLATION .....	4
3.1	LOCATING.....	4
3.2	UNPACKING.....	4
3.3	SETTING UP.....	5
4.0	KEYPAD .....	6
5.0	DISPLAYS .....	6
6.0	SYMBOLS AND INDICATORS.....	7
7.0	BATTERY OPERATION.....	7
8.0	BACKLIGHT .....	8
9.0	AUTO POWER OFF.....	8
10.0	OPERATION .....	8
10.1	ZEROING.....	8
10.2	TARING .....	9
10.3	WEIGHING .....	10
10.4	DETERMINING VALUE OF A PRODUCT BY WEIGHT .....	10
11.0	RS-232 .....	11
12.0	CALIBRATION.....	11
12.1	CALIBRATION PROCEDURE .....	11
12.2	SECURITY SEALS .....	11
12.3	CALIBRATION COUNTER.....	12
13.0	USER PARAMETERS.....	12
13.1	PRICE /KG AND /100G.....	13
13.2	BACKLIGHT.....	13
13.3	AUTO POWER OFF.....	14
13.4	AUTO CLEAR .....	14
13.5	CURRENCY SYMBOL.....	15
14.0	ERROR CODES.....	16
15.0	REPLACEMENT PARTS AND ACCESSORIES .....	16
16.0	SERVICE INFORMATION.....	17
17.0	WARRANTY INFORMATION .....	18
18.0	APPENDIX .....	19



## 1.0 INTRODUCTION

The **WBZ** series of digital price-computing scales are EC Type approved, (type approval number T7476/TC7477) and the **WBZ..aM** series are NTEP approved scales, (type approval number 10-082).

These scales provide an accurate, fast and versatile method of computing price by weight.

- Stainless steel weighing platform on an ABS plastic base assembly which is sealed to IP 65, making it water-proof
- Level indicator with adjustable levelling feet
- Colour coded, sealed keypad
- Large backlit liquid crystal displays (LCD) on both front and back panels
- Displays for **Weight**, **Unit Price** and **Total Price** (or Price to Pay)
- Price per 100g and per kilogram (Not applicable in some counties)
- Price displayed in multiple currency
- Auto-sleep function
- Battery operated for portability
- 50 hours battery life when fully charged

## 2.0 SPECIFICATIONS

	<b>WBZ 3</b>	<b>WBZ 6</b>	<b>WBZ 15</b>
Capacity, Max.=	3 kg	6 kg	15 kg
Resolution, d=e=	0.001 kg	0.002 kg	0.005 kg
Tare, T=	-3 kg	-6 kg	-9.995 kg

	<b>WBZ 6aM</b>	<b>WBZ 15aM</b>	<b>WBZ 30aM</b>
Capacity, Max.=	6 lb / 3 kg	<b>15 lb</b> / 6 kg	30 lb / 15 kg
Resolution, d=e=	0.002 lb / 0.001 kg	0.005 lb / 0.002 kg	0.01 lb / 0.005 kg
Tare, T=	-6 lb / -3 kg	-9.995 lb / -6 kg	-30 lb / -9.995 kg

Operating Temperature	-10°C to 40°C
Platform	210 x 173 mm
Overall	231 x 265 x 153 mm
Battery Life	50 hours typical*
Power	12 VDC, 800 mA Power Supply Module-supplied as standard
Net Weight	3.3 kg / 7.26 lb

\*Battery Life is less when the backlight is used.

## 3.0 INSTALLATION

### 3.1 LOCATING

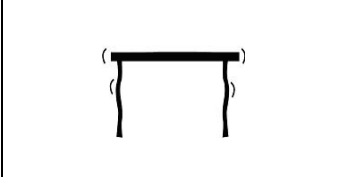
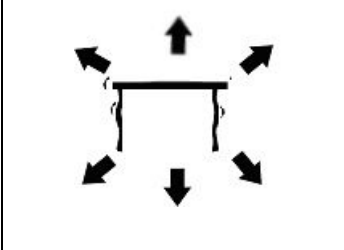
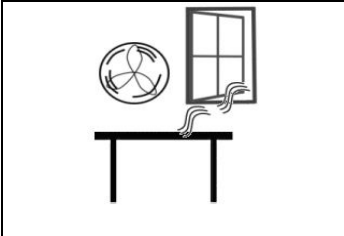
	<ul style="list-style-type: none"><li>• The scales should not be placed in a location that will reduce the accuracy.</li><li>• Avoid extremes of temperature. Do not place in direct sunlight or near air conditioning vents.</li><li>• Avoid unsuitable tables. The table or floor must be rigid and not vibrate.</li><li>• Avoid unstable power sources. Do not use near large users of electricity such as welding equipment or large motors.</li><li>• Do not place near vibrating machinery.</li><li>• Avoid air movement such as from fans or opening doors. Do not place near open windows or air-conditioning vents.</li><li>• Keep the scales clean. Do not stack material on the scales when they are not in use.</li></ul>
	
	
	

### 3.2 UNPACKING

Inside the box you will find-

- ✓ The Scale
- ✓ Stainless Steel Pan
- ✓ Power supply Module
- ✓ An Instruction manual

### 3.3 SETTING UP

- The scale comes with a stainless steel platform, packed separately.
- Place the platform on the top. Do not press with excessive force as that could damage the load cell inside.
- Level the scale by adjusting the four feet. A spirit level is located at the rear panel.
- The scale should be adjusted such that the bubble in the spirit level is in the centre of the level and the scale is supported by all four feet.

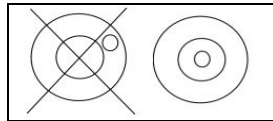

- Attach the power supply module to the bottom of the scale and plug into the mains.

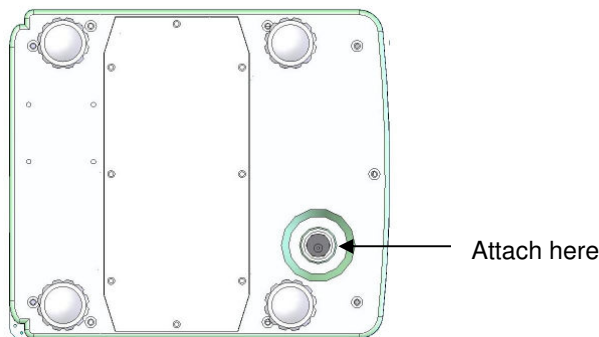

- Press the **[O/I]** key to start. The scale will first display the software revision, followed by a self-test.



- At the end of the self-test it will display zero weight, if the zero condition has been achieved and the weighing unit that was in use last. A stable and zero symbol indicators are also displayed.

## 4.0 KEYPAD

[0] to [9]	<p>Numeric entry keys to set the unit price.</p> <p><b>Some keys will have secondary functions if set at the factory which are as follows:</b></p> <p>[0] / kg/100g                      Select price per kg or per 100g          [1] / bL                              Black-light Control          [2] / SLEEp                        Control of Auto Off function          [4] / €,£,\$,R,¥,None          Selection of monetary Symbol</p> <p><b>NOTE: All secondary functions may not be enabled for all scales. This will depend on the location where the scale is used and the settings performed at the factory.</b></p>
[>Z<]	Sets a new zero point
[Tare]	Tares the scale to display zero.
[0/I]	Turns the power on and off.

## 5.0 DISPLAYS

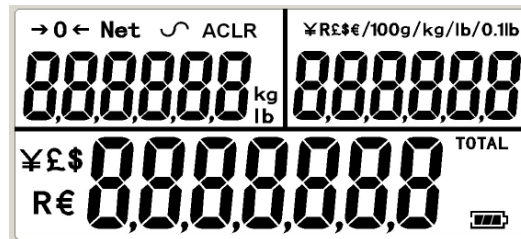

The display area is divided into 3 windows-



1. The **Weight** window shows the weight value along with the selected weighing unit. It also shows a zero, Net and stable symbol.
2. The **Unit Price** window has symbols to show the unit price per 100g or per kg.  
NOTE: Not allowed in some locations, this feature is disabled at the factory.
3. The **Total Price** window displays the price of the items on the scale. A symbol for the active currency is also shown.

The displays will show a decimal point for the **WBZ..aM** scales and a comma as shown above for the **WBW** scales.

A low battery symbol will indicate when the battery needs to be recharged.



## 6.0 SYMBOLS AND INDICATORS

Symbols	Description
→0←	Scale is in the zero position
Net	Net weight is being displayed
	Weighing result is stable
kg	Active weighing unit
/kg, /100 g	Price per kilogram or per 100g
	Indicates full battery strength. Will show less number of bars for weaker strength.
€,£,\$,R,¥, None	Active Currency

## 7.0 BATTERY OPERATION

- The scale has an internal rechargeable lead acid battery. This enables the scale operate for 50 hours when fully charged or less if the backlight is on.
- When the battery needs charging the low battery symbol will be on and the display will show “**LO bat**” for a few seconds before turning off. The battery should be charged immediately.
- To charge the battery, simply connect the power supply module to the bottom of the scale. The low battery symbol will flash during the time the battery is being charged. The scale need not be turned on, however the symbol will not be on if the scale is off.

- The battery should be charged for 12 hours for full capacity.
- Above the display is a LED to indicate the status of battery charging. When the scale is plugged into the mains power the internal battery will be charged. If the LED is green the battery is being charged. If it is red it is nearly discharged and yellow indicates the battery is increasing the charge level. Continue to charge overnight for a complete re-charge.

## 8.0 BACKLIGHT

The backlight for the LCD can be set by the user to always off, always on or automatic (on only when the scale is in use or a key is pressed). See section 13.2.

## 9.0 AUTO POWER OFF

The auto power off can be set by the user to disable the feature or to a pre-set time interval. See section 13.3.

## 10.0 OPERATION

### 10.1 ZEROING

- You can press the [**→Z←**] key when the pan is empty to set the zero point from which all other weighing is measured.
- When the zero point is obtained the **Weight** display will show the Zero symbol.

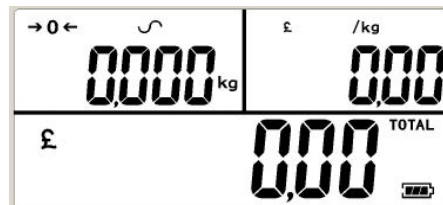

- The scale has an automatic re-zeroing function to account for minor drifting or accumulation of material on the platform. However you may need to press [**→Z←**] again to re-zero the scale if small amounts of weight are shown when the platform is empty.

## 10.2 TARING

- Taring is used to eliminate the weight of a container so that only the net weight is displayed. On the WBZ 15 scales the tare is limited to 9.995kg. Weight above this amount will not be tared.
- Zero the scale by pressing [**→Z←**] if necessary. The zero indicator will be on.

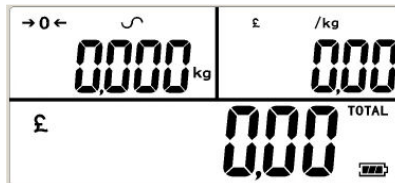

- Place an empty container on the platform. The weight of the container will be displayed.

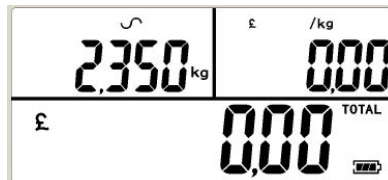

- Press [**Tare**] to zero the scale. The weight that was displayed is stored as the tare value and that value is subtracted from the display, leaving zero on the display. The **Net** indicator will be on. As product is added only the weight of the product will be shown.

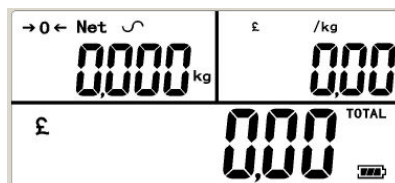

- When the product and container are removed the weight display will show a negative value. If a different container is to be used, remove this negative tare value by pressing the [**Tare**] once more.

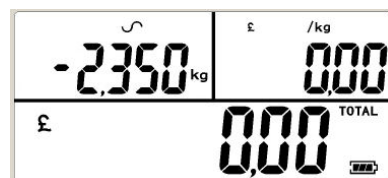

**Note:** If the capacity of the scale is 6000g and a container weighing 2350g is used and tared, the scale can then be used to weigh the material of up to 3650g.

### 10.3 WEIGHING

To determine the weight of a sample, first tare an empty container if used, then place the sample in the container. The **Weight** window will show the weight and the unit of weight currently in use.

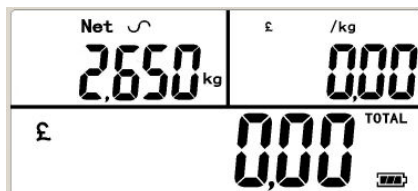

To hide the currency symbol, set the currency to “None”. See section 13.5.

### 10.4 DETERMINING VALUE OF A PRODUCT BY WEIGHT

- To determine the cost of a product by weight, it is necessary to enter the unit price per kilogram or per 100g using the numeric keys.
- The **Weight** display will show the net weight, the **Unit Price** display will show the price per kg or per 100g. The **Total Price** display will show the computed value for the total price.

**Example:**

	Display will show		
	Weight (in kg)	Unit Price (in selected currency)	Total Price (in selected currency)
Place a container on the scale and Press <b>[Tare]</b>	0.000	0.00	0.00
Place the items on the platform	1.300	0.00	0.00
Enter the unit price. The total price will be displayed.	1.300	5.00	6.50

- If a different unit price is required simply enter a new unit price. It may be necessary to remove the weight to return the scale to zero before a new value is allowed to be entered.

## 11.0 RS-232

Not available for WBZ Scales.

## 12.0 CALIBRATION

### 12.1 CALIBRATION PROCEDURE

The scales have methods to either prevent or control unauthorised calibration. If the Calibration Counters are enabled the scales can be calibrated without breaking the seals, however the counters will be incremented to identify a calibration or change in parameters.

If the scales do not have the counters enabled then access is controlled by breaking the seals on the scale to gain access to the circuit boards inside. See the figures on the security seal as given below.

**WARNING:** BREAKING OF THE SEALS MAY MAKE IT ILLEGAL TO USE THE SCALES FOR SALES OF GOODS. CONTACT YOUR TRADING STANDARDS OFFICE FOR FURTHER ASSISTANCE.

### 12.2 SECURITY SEALS

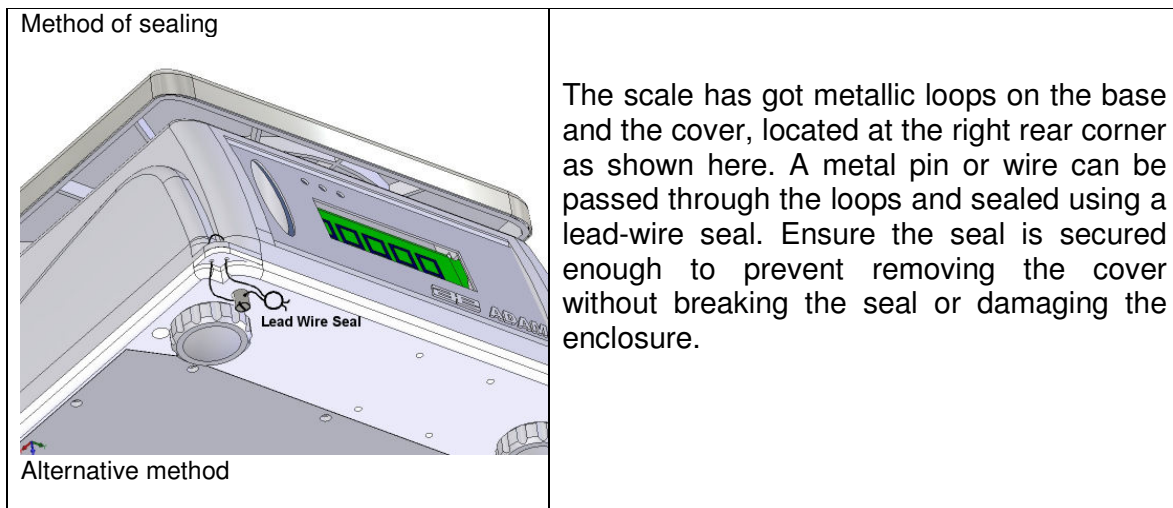

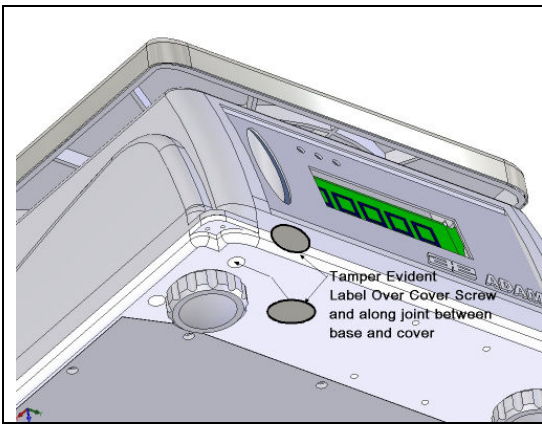

An alternative method would be to use tamper-evident labels over the screw on the bottom cover and over the joint between the top and the bottom cover as shown in the adjacent figure.

Metrology labels and additional security measures may be added to the scale as required by the national legislation.

**NOTE:** IF THIS SEAL IS BROKEN THE SCALE MUST BE RE-SEALED BY THE RELEVANT AUTHORITIES USING EITHER THE LEAD WIRE SEAL OR AN ACCEPTABLE SEAL BETWEEN THE COVER AND THE BASE.

**WBZ..aM SECURITY SEALS:** The device is equipped with a Category 1 Audit Trail. In addition a lead & wire and/or a paper security seal may be installed. To access the audit trail press the ( 5 ) button for 3 seconds. The display will flash the calibration counter and the configuration counter.

### 12.3 CALIBRATION COUNTER

The scales are sealed to prevent unauthorised calibration. However it is possible to calibrate the scales as the software includes a counter to keep track of how many times the scale has been calibrated and this value is recorded on the scale so that future inspections can see if the scale has had the counters incremented.

See the WBZ Service manual for details.

## 13.0 USER PARAMETERS

The user has access to the following parameters to change the way the scale will operate. **Some of these parameters can not be set by the user if they are disabled at the factory.**

To access these parameters hold the specific keys as described in the following sections for about **4 seconds** during the normal operation. The respective parameter will be shown with the current setting sounding a beep.

To change the setting-

- Press the **[0]** key to scroll through the available options.
- When the desired setting is displayed, press the **[Tare]** key to save the setting. The scale will return to weighing.
- Press the **[→Z←]** key to exit a parameter.

### 13.1 PRICE /kg AND /100g

**NOTE: Not applicable for South Africa and Far East as this feature is disabled at the factory.**

The scale can be set to display the total cost using the unit price per kilogram or the price per 100g. To set this parameter-

- Press and hold the **[0]** key for about **4 seconds** during the normal operation.
- Press the **[0]** key to toggle between “**Unit kg**” and “**Unit 100g**”.
- Press **[Tare]** to save the desired setting. The scale will return to weighing

### 13.2 BACKLIGHT

The backlight may be set by the user. If the backlight is set to off, the battery life will be maximised. With the backlight in operation the battery life will be less depending on the extent the scale is used. To set this parameter-

- Press and hold the **[1]** key for about **4 seconds** during the normal operation.
- Press the **[0]** key to scroll through the following options-

“ <b>bl</b> ” “ <b>AU</b> ”	Backlight will be automatically on when a weight is on the platform or when a key is pressed and will turn off after a few seconds when the weight is zero or after a while, the last key was pressed.
“ <b>bl</b> ” “ <b>off</b> ”	Backlight will be always off
“ <b>bl</b> ” “ <b>on</b> ”	Backlight will be always on

- Press **[Tare]** to save the desired setting. The scale will return to weighing

### 13.3 AUTO POWER OFF

This parameter may be enabled or disabled by the user. If enabled, when the scale is not used for some time (as pre-set by the user under this function) it will switch off automatically. To set this parameter-

- Press and hold the **[2]** key for about **4 seconds** during the normal operation.
- Press the **[0]** key to scroll through the following options-

<b>“SLEEP”</b>	<b>“ModE”</b>	<b>“0”</b>	Auto sleep mode disabled
<b>“SLEEP”</b>	<b>“ModE”</b>	<b>“1”</b>	Auto sleep after 1 minute
<b>“SLEEP”</b>	<b>“ModE”</b>	<b>“5”</b>	Auto sleep after 5 minutes
<b>“SLEEP”</b>	<b>“ModE”</b>	<b>“10”</b>	Auto sleep after 10 minutes
- Press the **[Tare]** key to save the desired setting. The scale will return to weighing.

### 13.4 AUTO CLEAR

The scale can be set to clear or retain the current unit price when the weight on the scale is removed. To set this parameter-

- Press and hold the **[3]** key for about **4 seconds** during the normal operation.
- Press the **[0]** key to scroll through the following options-

<b>“A Clr”</b>	<b>“on”</b>	Automatically clear the price per unit price when the weight on the scale is removed
<b>“A Clr”</b>	<b>“off”</b>	Will not automatically clear the unit price so that other items of the same cost can be weighed.
- Press **[Z/T]** to save the desired setting. The scale will return to weighing

**NOTE:** If the Auto Clear function is not available (disabled at the factory) the scale will double beep and continue without interruption when the **[3]** key is held for 4 seconds.



## 13.5 CURRENCY SYMBOL

User can select the currency symbol from the options- €, £, \$, R, ¥, None (no symbol). To set the currency-

- Press and hold the **[4]** key for about **4 seconds** during the normal operation
- Press the **[0]** key to scroll through the following options
- Press the **[Tare]** key to save the desired setting. The scale will return to weighing. The selected symbol is displayed in the **Unit Price** and **Total Price** window.

## 14.0 ERROR CODES

During the initial power-on testing or during operation, the scale may show an error message. If an error message is shown, repeat the step that caused the message. If the error is still shown contact your supplier for support.

<b>ERROR</b>	<b>DESCRIPTION</b>	<b>POSSIBLE CAUSES</b>
<b>Err 4</b>	Initial Zero is greater than allowed when power is turned on or the Zero key is pressed.	Weight is on the pan when turning the scale on. Excessive weight on the pan when zeroing scale. Improper calibration of the scale. Damaged load cell. Damaged Electronics.
<b>Err 6</b>	A/D count is not correct when turning the scale on.	Platform is not installed. Load cell is damaged. Electronics is damaged.

## 15.0 REPLACEMENT PARTS AND ACCESSORIES

If you need to order any spare parts and accessories, contact your supplier or Adam Equipment. A partial list of such items is as follows-

<ul style="list-style-type: none"><li>• <b>Power Supply Module</b></li><li>• <b>Replacement Battery</b></li></ul>	<ul style="list-style-type: none"><li>• <b>Stainless Steel Pan</b></li><li>• <b>In use cover</b></li></ul>
---	--

## 16.0 SERVICE INFORMATION

This manual covers the details of operation. If you have a problem with the scale that is not directly addressed by this manual then contact your supplier for assistance. In order to provide further assistance, the supplier will need the following information which should be kept ready:

### A. Details of your company

- Name of your company:
- Contact person's name:
- Contact telephone, e-mail, fax or any other methods:

### B. Details of the unit purchased

(This part of information should always be available for any future correspondence. We suggest you to fill in this form as soon as the unit is received and keep a print-out in your record for ready reference.)

<b>Model name of the scale:</b>	<b>WBZ _____</b>
<b>Serial number of the unit:</b>	
<b>Software revision number (Displayed when power is first turned on):</b>	
<b>Date of Purchase:</b>	
<b>Name of the supplier and place:</b>	

### C. Brief description of the problem

Include any recent history of the unit. For example:

- Has it been working since it's delivered
- Has it been in contact with water
- Damaged from a fire
- Electrical Storms in the area
- Dropped on the floor, etc.

## 17.0 WARRANTY INFORMATION

Adam Equipment offers Limited Warranty (Parts and Labour) for the components failed due to defects in materials or workmanship. Warranty starts from the date of delivery.

During the warranty period, should any repairs be necessary, the purchaser must inform its supplier or Adam Equipment Company. The company or its authorised Technician reserves the right to repair or replace the components at any of its workshops depending on the severity of the problems. However, any freight involved in sending the faulty units or parts to the service centre should be borne by the purchaser.

The warranty will cease to operate if the equipment is not returned in the original packaging and with correct documentation for a claim to be processed. All claims are at the sole discretion of Adam Equipment.

This warranty does not cover equipment where defects or poor performance is due to misuse, accidental damage, exposure to radioactive or corrosive materials, negligence, faulty installation, unauthorised modifications or attempted repair or failure to observe the requirements and recommendations as given in this User Manual. Additionally rechargeable batteries (where supplied) are not covered under warranty.

Repairs carried out under the warranty does not extend the warranty period. Components removed during the warranty repairs become the company property.

The statutory right of the purchaser is not affected by this warranty. The terms of this warranty is governed by the UK law. For complete details on Warranty Information, see the terms and conditions of sale available on our web-site.

## 18.0 APPENDIX

### Parameter Layout for WBZ Scales (Sec 13.0)

Key functions while in the parameter setting section:

- [Tare] Enter and store the value or option shown
- [0] Move to the next selection or parameter
- [→Z←] Return to a previous parameter or return to weighing.

#### Price /kg or /100g

#### Backlight

#### Auto Power Off

#### Currency

Press the [0] key for 4 seconds while  
in normal weighing mode

Press the [1] key for 4 seconds while  
in normal weighing mode

Press the [2] key for 4 seconds while  
in normal weighing mode

Press the [4] key for 4 seconds while  
in normal weighing mode

Press the [0] key to change

Unit kg  
Unit 100g

Press the [0] key to change

EL oFF  
EL on  
EL AU

Press the [0] key to change

SLP 0  
SLP 1  
SLP 5  
SLP 10

Press the [0] key to change

nonE  
€  
£  
\$  
R  
¥

Press the [Tare] key

Press the [Tare] key

Press the [Tare] key

Press the [Tare] key



Adam Equipment

ADAM EQUIPMENT, BOND AVENUE, DENBIGH EAST INDUSTRIAL ESTATE,  
MILTON KEYNES, MK1 1SW, U.K.

Tel: (01908) 274545 Fax: (01908) 641339  
Intl Tel: -44 1908 -274545 Intl Fax: -44 1908 641339  
E-Mail Address: [info@Adamequipment.co.uk](mailto:info@Adamequipment.co.uk)

	Declaration of Conformity	Verklaring van overeenstemming
	Konformitätserklärung	Dichiarazione di Conformità
	Déclaration de Conformité	Declaración de Conformidad

The non-automatic weighing instrument  
Die nicht-automatischen Wägeapparate  
L'instrument de pesage à fonctionnement non automatique

Het niet-automatische weegwerktuig  
Strumento per pesatura non automatico  
Instrumento para pesaje no automatico



Manufacturer :	Adam Equipment Co. Ltd.	Hersteller :	Adam Equipment Co. Ltd.	Fabricant :	Adam Equipment Co. Ltd.
Type:	WBW../WBZ	Typ:	WBW../WBZ	Type:	WBW../WBZ
No of the EC type-approval certificate:	T7476/TC7477	Nr. der EG-Bauartzulassung:	T7476/TC7477	N° du certificate d'approbation CE de type:	T7476/TC7477
Corresponds to the production model described in the EC type-approval certificate and to the requirements of the Council Directive 90/384/EEC as amended and to the requirements of the following EC Directives:		Entspricht dem in der Bescheinigung über die Bauartzulassung beschriebenen Baumuster, sowie den Anforderungen der EG-Richtlinie 90/384/EWG in der jeweils geltenden Fassung und den Anforderungen folgender EG-Richtlinien:		Correspond au modèle décrit dans le certificat d'approbation CE de type, aux exigences de la directive 90/384/CEE modifiée et aux exigences des directives CE suivantes:	
2006/95/EC	Electrical equipment for use within certain voltage limits (Low Voltage Directive)	2006/95/EC	Elektrische Betriebsmittel zur Verwendung innerhalb bestimmter Spannungsgrenzen (Niederspannungsrichtlinie)	2006/95/EC	Matériel électrique pour utilisation dans des limites de tension définies (Directive Basse Tension)
2004/108/EC	Electromagnetic compatibility	2004/108/EC	Elektromagnetische Verträglichkeit	2004/108/EC	Compatibilité électromagnétique
This declaration is only valid when accompanied by a Certificate of Conformity issued by a Notified Body.		Diese Erklärung gilt nur in Verbindung mit einer Konformitätsbescheinigung einer benannten Stelle		Cette déclaration est seulement valide quand elle est accompagnée par une Attestation de Conformité délivrée par un Organisme Notifié.	

Fabrikant :	Adam Equipment Co. Ltd.	Produttore	Adam Equipment Co. Ltd.	Fabricante	Adam Equipment Co. Ltd.
Type:	WBW../WBZ	Modello:	WBW../WBZ	Tipo:	WBW../WBZ
Nummer van de Verklarling van EG-typegoedkeuring	T7476/TC7477	N. di certificato di approvazione di tipo CE	T7476/TC7477	Numero del certificado de aprobacion de tipo CE:	T7476/TC7477
Conform met het model beschreven in de verklaring van EG-typegoedkeuring in met de voorschriften van EG richtlijn 90/384/EEC zoals gewijzigd en met de volgende EG richtlijnen:		Conforme al modello di produzione descritto nel certificato di approvazione di tipo CE e secondo le richieste CE direttivo 90/384/CEE come modificato e secondo le richieste della seguente directive CE		Conforme al modello di produzione descritto nel certificado di aprobacion del tipo CE e segun los requisitos del CE diretiva 90/384/CEE como modificado e segun los requisitos della siguiente directive CE	
2006/95/EC	Laagspanning richtlijn	2006/95/EC	Strumenti elettrici per uso entro certi limiti di voltaggio ( Direttivo di voltaggio basso)	2006/95/EC	Instrumentos electricos para uso dentro ciertos limites del voltaje ( Directivo di voltaje bajo )
2004/108/EC	EMC richtlijn	2004/108/EC	Compatibilita elettromagnetico	2004/108/EC	Compatibilidad electromagnetico
Deze verklaring is alleen geldig samen met een certificaat van overeenstemming afgegeven door een bevoegde instantie.		Questa dichiarazione e valida solamente se accompagnato da un certificato di conformita relaciao da un ente riconosciuto.		Esta declaracion es valida solamente si acompañado a un certificado da conformidad emitida par un organismo notificado.	

Signature  
Unterschrift  
Signature  
Handtekening  
Firma  
Firma

J.S. Cumbach  
Technical Manager

Date  
Datum  
Date  
Datum  
Date  
Date  
Fecha

4 December 2008

### ***FCC COMPLIANCE***

This equipment has been tested and found to comply with the limits for a Class A digital device, pursuant to Part 15 of the FCC Rules. These limits are designed to provide reasonable protection against harmful interference when the equipment is operated in a commercial environment. The equipment generates, uses, and can radiate radio frequency energy and, if not installed and used in accordance with the instruction manual, may cause harmful interference to radio communications. Operation of this equipment in a residential area is likely to cause harmful interference in which case the user will be required to correct the interference at his own expense.

Shielded interconnect cables must be employed with this equipment to insure compliance with the pertinent RF emission limits governing this device.

Changes or modifications not expressly approved by Adam Equipment could void the user's authority to operate the equipment.

### ***WEEE COMPLIANCE***

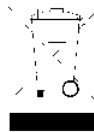

Sealed Lead Acid  
Battery  
Must be recycled  
Properly

Any Electrical or Electronic Equipment (EEE) component or assembly of parts intended to be incorporated into EEE devices as defined by European Directive 2002/95/EEC must be recycled or disposed using techniques that do not introduce hazardous substances harmful to our health or the environment as listed in Directive 2002/95/EC or amending legislation. Battery disposal in Landfill Sites is more regulated since July 2002 by regulation 9 of the Landfill (England and Wales) Regulations 2002 and Hazardous Waste Regulations 2005. Battery recycling has become topical and the Waste Electrical and Electronic Equipment (WEEE) Regulations are set to impose targets for recycling.

**ADAM EQUIPMENT** is an ISO 9001:2008 certified global company with more than 35 years experience in the production and sale of electronic weighing equipment.

Adam products are predominantly designed for the Laboratory, Educational, Medical, retail and Industrial Segments. The product range can be described as follows:

- Analytical and Precision Balances
- Compact and Portable Balances
- High Capacity Balances
- Moisture analysers / balances
- Mechanical Scales
- Counting Scales
- Digital Weighing/Check-weighing Scales
- High performance Platform Scales
- Crane scales
- Medical Scales
- Retail Scales for Price computing

For a complete listing of all Adam products visit our website at  
[www.adamequipment.com](http://www.adamequipment.com)

© Copyright by Adam Equipment Co. Ltd. All rights reserved. No part of this publication may be reprinted or translated in any form or by any means without the prior permission of Adam Equipment.

Adam Equipment reserves the right to make changes to the technology, features, specifications and design of the equipment without notice.

All information contained within this publication is to the best of our knowledge timely, complete and accurate when issued. However, we are not responsible for misinterpretations which may result from the reading of this material.

The latest version of this publication can be found on our Website.

[www.adamequipment.com](http://www.adamequipment.com)