

SB Series

Digital Bench Scales

Instruction Manual

Revision 1.3 April 5, 2000

SB-30

SB-70

SB-150

AND
A&D WEIGHING
...Clearly a Better Value

1555 McCandless Drive, Milpitas, CA 95035
Tel: (800) 726-3364 / (408) 263-5333 * Fax: (408) 263-0119
Fax-on-Demand: (800) 726-7099, Press 2 * Website: www.andweighing.com
Email: scales@andweighing.com

ATTENTION:

To extend the life of your digital scale, do not drop items to be weighed onto the platform or overload the scale beyond its rated capacity. Shock-loading and overloading may damage the load cell and void the warranty.

Table of Contents

Introduction	2
Installation and Wiring.....	3
Display Overview.....	4
Keyboard Functions	5
User Menu Mode.....	6
Setup Menu Mode.....	7
Calibration	9
APPENDIX A: Specifications	11
APPENDIX B: Troubleshooting the Serial Port.....	12
APPENDIX C: Displayed Error Codes	13
APPENDIX D: Warranty and Service Information.....	14

Introduction

The SB-30/70/150 Digital Bench Scales are compact bench scales with display and five function keyboard. It is available in 30 lb (15 kg), 70 lb (30 kg) and 150 lb (70 kg) capacities. It comes standard with a bright LED screen for easy readout, a removable stainless steel platform, and an RS-232C serial communication port.

These scales can be configured to display their divisions in two separate modes – non-NTEP mode and NTEP mode. The scale is shipped from the factory configured in NTEP mode. The NTEP mode is supplied for scales which need to comply with Handbook

44 requirements. To re-configure the scale, please refer to the “Setup Menu Mode” section of the manual.

SB-30/70/150 use full duplex RS-232C serial format for communication with personal computers or remote displays. Units can transmit data on demand or continuously in several popular data protocols.

Each scale’s serial communication parameters are altered through the User menu The “User Menu Mode” section of the manual explains how to use the five front panel keys to maneuver and save settings in this menu.

Installation and Wiring

The scale's back panel comes equipped with a female DSUB-9 connector for the RS-232 serial port, a jack for DC power input, a calibration switch, a remote display connector (SB-30 & SB-70 only) and an ON/OFF rocker switch. To install the scale, simply plug the enclosed AC Wall Adapter into the scale's DC power jack first, then into an AC outlet (115 VAC only). For SB-30 and SB-70 scales, plug in the remote display/keyboard unit. Finally, turn the rocker switch to the ON ("1") position. The scale is now ready for use.

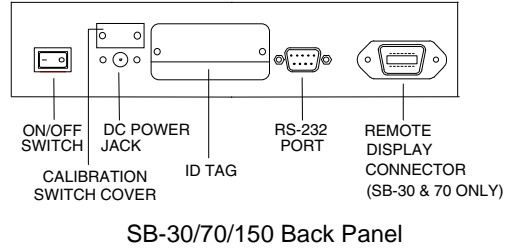

The female 9-Pin RS-232 connector is used to interface to a PC. Shown at right are the pin assignments for the connector.

Pin No.	Pin Name
2	Receive Data
3	Transmit Data
5	Signal Ground

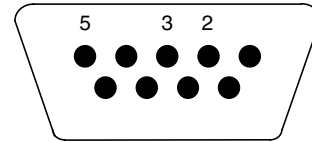

9-pin RS-232 connector (female)

Shown at right is the suggested cable diagram for direct connection to a PC. Or, you can order the optional pre-wired NMC-1 Null Modem Cable

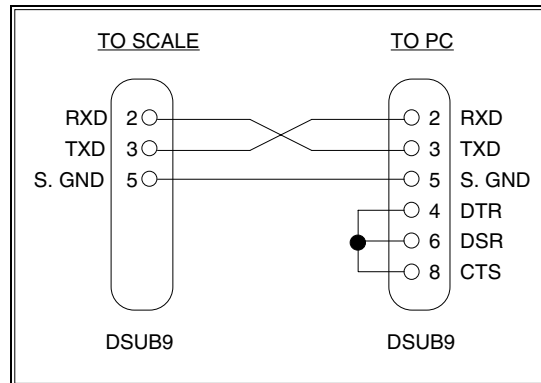

FIGURE 1. Cable Diagram for Scale to IBM PC

Display Overview





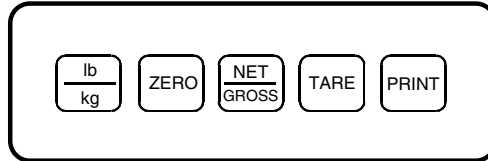

SB-30/70/150 Display Area

ANNUNCIATOR	MEANING
ZERO	Better known as the "Center of Zero" annunciator, this light is active whenever the displayed weight is within ± 0.25 divisions of true zero.
NET	Indicates that the scale is displaying net weight.
GROSS	Indicates that the scale is displaying gross weight.
TARE	Indicates that the tare weight in the system was established by means of the push button method.
lb and kg	Indicates the unit of the displayed weight.
STABLE	This light indicates that the scale is in equilibrium.

Keyboard Functions

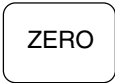

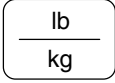
SB-30/70/150 Series Keyboard

KEY	FUNCTION
	Sets scale to display "0" only when a) in Gross mode, b) not in overload and c) not in motion.
	Toggles between Gross and Net weight display if a tare has been established.
	Used to establish the weight on the platform as the tare weight. You cannot establish zero or negative gross weight as a tare. Also, the scale must not be in motion or in overload.
	Toggles between lb and kg units if enabled in the User ("A") Menu.
	Sends "Print" data to serial port if scale is not in motion or in overload.

User Menu Mode

SB-30/70/150 includes a User menu which contains the scale's serial communication parameters. It consists of 5 separate menu selections, each also with its own sub-menu of choices.

To change a listed parameter, you must first enter the User Menu mode. Once there, four of the front panel keys become directional navigators to move around in the menus, and one key is used to save or SET the selections.

To place the unit in User menu mode:

1. Turn the power off to the unit.
2. While holding down the **lb/kg** key, turn the power back on.
3. When the display shows "A1", the unit is in User Menu mode, and you can release the **lb/kg** key. Shown at right are the directional and SET key assignments

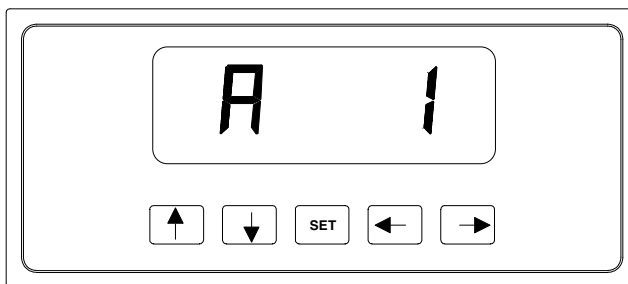

USER MENU CHART

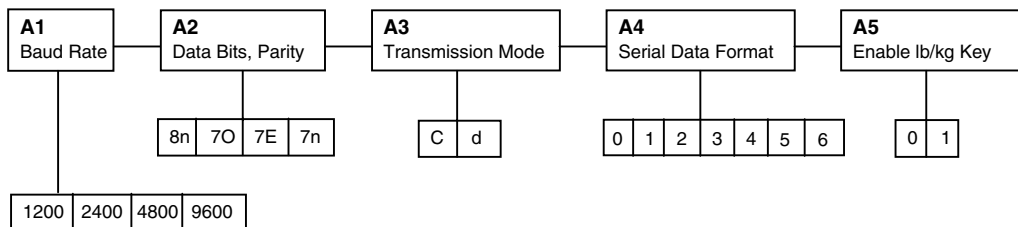

To place the unit back into the Normal Operating mode:

1. Turn off the scale. Turn the scale back on without pressing any keys.
2. The display will go through a digit check, then settle into Normal Operating mode. All front panel keys will now return to their normal mode of operation.

User Menu Mode / Continued

USER MENU DESCRIPTIONS

NAME/CODE	DESCRIPTION	CODE/VALUE
A1 Baud Rate	Selects the baud rate for data transmission through the serial port.	1200 2400 4800 9600
A2 Data Bits and Parity	Selects the number of data bits and parity of serial transmission. "8n" = 8 data bits with no parity bit and one stop bit "7O" = 7 data bits with odd parity bit and one stop bit "7E" = 7 data bits with even parity bit and one stop bit "7n" = 7 data bits with no parity bit and two stop bits	8n 7O 7E 7n
A3 Mode of Serial Transmission	Selects when data will be sent out of the serial port to a printer or computer: "C" = Continuous mode; send data continuously "d" = Demand mode; send data when a PRINT command is issued from the printer, computer, or scale.	C d
A4 Serial Data Format	Selects the data format to be transmitted via the serial port to a printer or computer. "0" = Consolidated Controls Format "1" = Toledo 8213 Format "2" = A&D/NCI/CAS Format "3" = Transcell Technology Format "4" = Detecto ASD Format "5" = Triner Format "6" = Fairbanks 70-2453-4 Format	0 1 2 3 4 5 6
A5 Disable the lb/kg Key	Allows the lb/kg key to be disabled so that an operator cannot accidentally press the key and change the displayed units. "0" = Disable the lb/kg key "1" = Enable the lb/kg key	0 1

Setup Menu Mode

SB-30/70/150 scale include a Setup menu which determines the scale's display mode, allows scale calibration and also contains the scale's adjustable functional parameters. It consists of 5 separate menu selections, each also with its own sub-menu of choices.

To change a listed parameter, you must first enter the Setup Menu mode. Once there, four of the front panel keys become directional navigators to move around in the menus, and one key is used to save or SET the selections.

Setup Menu Mode / Continued

To place the unit in Setup menu mode:

1. Turn the power off to the unit.
2. Locate the calibration switch on the scale's back panel and toggle to the opposite position.
3. While holding down both the **ZERO** and **PRINT** keys, turn the power back on.
4. When the display shows "F1", the unit is in Setup Menu mode, and you can release the two keys. Shown at right are the directional and SET key assignments

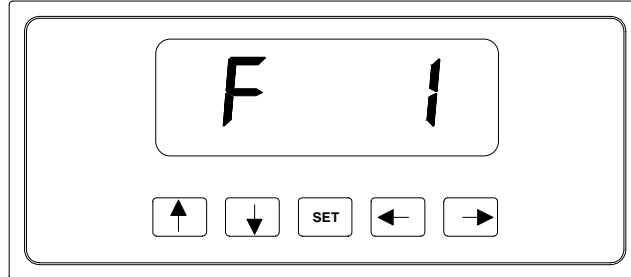

SETUP MENU CHART

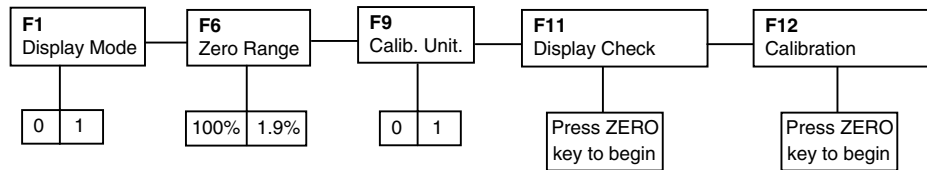

To place the unit back into the Normal Operating mode:

1. With the scale on or off, toggle the Calibration Switch back to its original position. Turn the scale back on without pressing any keys.
2. The display will go through a digit check, then settle into Normal Operating mode. All front panel keys will now return to their normal mode of operation.
3. There is an **F13** sub-menu present that is for **FACTORY USE ONLY!**

Setup Menu Mode / Continued

SETUP MENU DESCRIPTIONS

NAME/CODE	DESCRIPTION	CODE/VALUE
F1 Display Mode	Selects display mode for the scale. "0" = Non-NTEP mode "1" = NTEP mode	0 1
F6 Zero Range	Selects the range within which the scale may be zeroed. Note that the scale must be in standstill to zero the scale.	100% 1.9%
F9 Calib. Unit	Selects the primary base unit to be used in the calibration process. Also the default unit for normal operation. "0" = primary unit is lb. "1" = primary unit is in kg.	0 1
F11 Display Check	Actuates the function which illuminates all digit segments, decimal points, and LCD annunciators in a test sequence. Pressing the ZERO key to scroll down one level begins the test sequence.	Press ZERO key to begin sequence
F12 Calibration	Places scale into the calibration routine. Scrolling down with the ZERO key one level begins the procedure.	Press ZERO key to begin sequence
F13 Factory Reset	This sub-menu will reset all parameters in the "F" and "A" menus to the default settings. USE WITH CAUTION!!!!	Press the ZERO key twice to execute.

Calibration

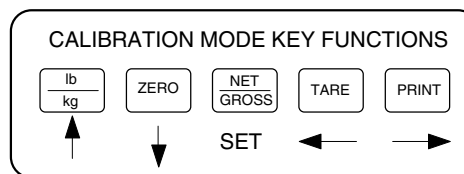
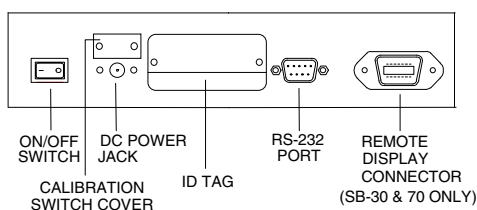

The scale can be calibrated by following the procedure shown below. The minimum test weight and the recommended test weight depends on the scale's capacity.

For the SB-30, the minimum test weight is 0.3 lb (0.15 kg) , and the recommended test weight is 20 lb (10 kg). For the SB-70, the minimum test weight is 0.7 lb (0.35 kg) , and the recommended test weight is 47 lb (23 kg). For the SB-150, the minimum test weight is 1.5 lb (0.7 kg) , and the recommended test weight is 100 lb (50 kg).

Calibration / Continued

To calibrate the scale:

1. If you are already in Setup Menu Mode, scroll to "**F 12**" and press the **ZERO** key. Otherwise, turn the scale off and set the Calibration Switch on the back panel to the opposite position. Turn the unit back on.

The message "**C 0**" appears on the display briefly, followed by a value which remains on the screen. Allow a 20 minute warm-up period for the load cell and other electronics to become thermally stable.

2. Press **ZERO** to zero the value, then press the **NET/GROSS** key to save the zero point value.
3. The display will momentarily prompt "**C 1**" for the span calibration, followed by "**0.00**" with one digit flashing. Place the test weight on the platform.
4. Use the four directional keys to adjust the displayed value to the actual test weight value in pounds. Increase the flashing digit by pressing the **lb/kg** key. Decrease the flashing digit by pressing the **ZERO** key. The position of the flashing digit may be changed by pressing the **PRINT** key or the **TARE** key.
5. After setting the exact value, press the **NET/GROSS** key to save the value.
6. If the calibration was successful, the display will show "**ECAL**" momentarily, then freeze. Exit the Calibration mode and enter the Normal Operating Mode by positioning the Calibration Switch back to its original position.
7. If the calibration was not successful, one of the error messages below will appear. Take the indicated action to correct the problem, then perform a new calibration.

"**Err0**" - The calibration test weight or the adjusted keyed-in weight is larger than full scale. Change the calibration test weight or check the keyed-in weight.

"**Err1**" - The calibration test weight or the adjusted keyed-in weight is smaller than 1% of full scale. Change the calibration test weight or check the keyed-in weight.

"**Err2**" - Check keyed-in weight with the actual weight placed on platform.

To place the unit back into the Normal Operating mode:

1. Toggle the Calibration Switch back to its original position.
2. The display will go through a digit check, then settle into Normal Operating mode. All front panel keys will now return to their normal mode of operation.

APPENDIX A: Specifications

MODEL	Non Legal-for-trade Capacity	Legal-for-trade Capacity
SB-30	0 - 5 x 0.005 lb (0 - 2 x 0.002 kg) 5 - 30 x 0.02 lb (2 - 15 x 0.01 kg)	0 - 30 x 0.01 lb (0 - 15 x 0.005 kg)
SB-70	0 - 5 x 0.005 lb (0 - 2 x 0.002 kg) 5 - 70 x 0.02 lb (2 - 30 x 0.01 kg)	0 - 70 x 0.05 lb (0 - 30 x 0.02 kg)
SB-150	0 - 5 x 0.01 lb (0 - 2 x 0.005 kg) 5 - 70 x 0.02 lb (2 - 30 x 0.01 kg) 70 - 150 x 0.05 lb (30 - 70 x 0.02 kg)	0 - 150 x 0.05 lb (0 - 70 x 0.02 kg)

CONSTRUCTION:

Base: Steel and ABS
Platform: Stainless Steel
Feet: Non-skid Hard Rubber

DISPLAY:

6 Digit, 0.6", 7-Segment Green LED

OVER CAPACITY ANNUNCIATION:

102% of Full Scale Capacity

OPERATING TEMPERATURE RANGE:

32 F to 104 F (0°C to 40°C)

PLATTER SIZE:

SB-30/70: 10" x 13"

SB-150: 13" x 13"

POWER SOURCE:

AC Adapter, 12VDC, 500mA

WEIGHT:

Net Weight: 24.3 lb (11 kg)

Shipping Weight: 27.8 lb (12.6 kg)

PHYSICAL DIMENSIONS

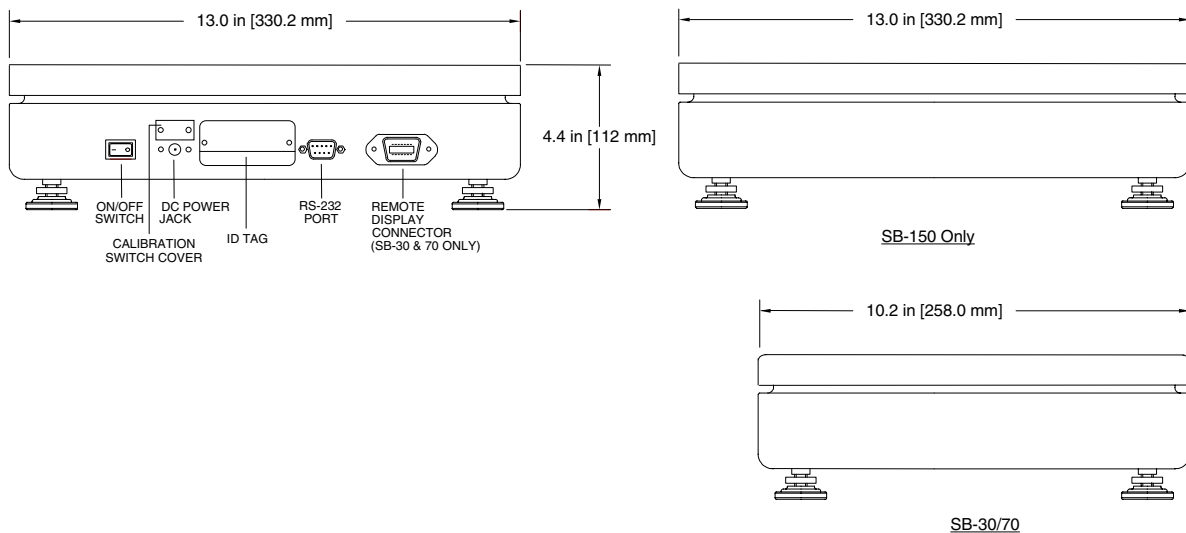

APPENDIX B: Troubleshooting the Serial Port

The scale's serial port operation can be verified by following the procedure below. This procedure makes use of HyperTerminal - a serial port communication program bundled with Windows 95 and Windows 98 operating systems.

A comprehensive summary of the various Serial Data Formats (SDF's) can be found in the SB Series Service Manual.

To test the scale's serial port for proper operation:

1. Connect the NMC-1 Null Modem Cable or equivalent between the scale and your PC. Make sure to note which communication port (i.e. COM1, COM2) you are using on the PC.
2. On the scale, select the desired setting in the User Menu, including baud rate (A1), Data Bits and Parity (A2), mode (A3), and serial data format (A4). Note that all Transcell scales have a fixed parameter of one (1) stop bit.
3. On your PC, run HyperTerminal. Select the proper settings for the following using the scale's settings:
 - Baud Rate
 - Data Bits
 - Parity
 - Stop Bits = 1
4. Enable the CAPS LOCK key on your PC.
5. This test verifies that the scale is transmitting properly. If the scale is set to Demand mode, pressing the **PRINT** key on the scale should echo the weight readout on the PC screen. If the Continuous mode has been selected on the scale, the PC screen will overrun with weight information.

NOTE: The TOLEDO, A&D/NCI/CAS, FAIRBANKS and TRINER formats do not support a Continuous mode.

6. This test verifies that the scale is receiving properly. Use the table below to determine the valid commands for your serial data format setting. For example the 'P' command is executed by pressing the capital "P" key on your PC keyboard. Unless otherwise specified, you do not need to press the ENTER key on your PC.

NOTE1: If the scale is set to Continuous mode, the print commands will be ignored.

NOTE2: If the scale is in motion, the print commands will be ignored for most SDF's.

FUNCTION	FORMAT(S)	COMMAND
Print the weight	CONSOLIDATED & TRANSCCELL	'P'
	TOLEDO	'W'
	A&D/NCI/CAS & TRINER	'W' + <ENTER>
	DETECTO	'~'
	FAIRBANKS	<ENTER>

APPENDIX C: Displayed Error Codes

CODE	MODE	MEANING / POSSIBLE SOLUTION
▣▣▣▣▣▣	Normal Operating Mode	A weight greater than 102% of the scale's capacity has been applied to the scale. Remove the weight from the platter. Try re-calibrating the scale if this doesn't solve the problem. Otherwise, possible load cell damage due to overloading.
-----	Normal Operating Mode	Underrange condition. Platter has been removed. Re-install platter. Try re-calibrating the scale if this doesn't solve the problem. Otherwise, possible load cell damage due to shock loading.
- HI -	Warmup Mode	The scale has been turned on with a weight already present on the platter. Remove the weight and then press the ZERO key if necessary. Try re-calibrating the scale if this doesn't solve the problem. Otherwise, possible load cell damage due to overloading.
- LO -	Warmup Mode	The scale has been turned on without the platter installed. Install the platter and then press the ZERO key if necessary. Try re-calibrating the scale if this doesn't solve the problem. Otherwise, possible load cell damage due to shock loading.
Err 0	Calibration Mode	Keyed-in weight value in Calibration Mode is less than 1% of the scale's capacity. Use a larger test weight or re-adjust value.
Err 1	Calibration Mode	Keyed-in weight value in Calibration Mode is larger than the scale's capacity. Use a smaller test weight or re-adjust value.
Err 2	Calibration Mode	Internal resolution is not high enough to process keyed-in weight value in Calibration Mode. Verify test weight and value.
Err 3	All Modes	Diagnostics check error - EEPROM Read
Err 4	All Modes	Diagnostics check error - EEPROM Write

APPENDIX D: Warranty and Service Information

Seller warrants that each SB-30/70/150 will conform to written specifications, drawings, and other descriptions made by the manufacturer, including any modifications thereof. Seller warrants the goods against faulty workmanship and defective materials. If any goods fail to conform to these warranties, Seller will, as its sole and exclusive liability hereunder, repair or replace such goods if they are returned within the following warranty period: **Two (2) years from date of shipment**. This warranty is made upon the express condition that:

- 1) Buyer notifies Seller of such non-conformity with detailed explanation of alleged deficiencies.
- 2) Product should not be returned without prior notice to Seller.
- 3) Other than setup functions & calibration, such goods have not been modified, altered, or changed by any person other than the Seller or its duly authorized repair agents.
- 4) Examination of such goods by Seller discloses that the nonconformity actually exists and was not caused by accident, misuse, neglect, alteration, improper installation improper or unauthorized repair, or improper testing.
- 5) Seller will have a reasonable time to repair or replace such goods.

THESE WARRANTIES EXCLUDE ALL OTHER WARRANTIES, EXPRESS OR IMPLIED, ORAL OR WRITTEN, INCLUDING WITHOUT LIMITATION WARRANTIES OF MERCHANTABILITY OR FITNESS FOR A PARTICULAR PURPOSE. SELLER WILL NOT IN ANY EVENT BE LIABLE FOR INCIDENTAL OR CONSEQUENTIAL DAMAGES. IN ACCEPTING THIS WARRANTY, THE PURCHASER OR BUYER AGREES TO WAIVE ANY AND ALL OTHER CLAIMS FOR RIGHT TO WARRANTY FROM A&D WEIGHING. SHOULD THE SELLER BE OTHER THAN A&D WEIGHING, BUYER AGREES TO LOOK ONLY TO THE SELLER FOR WARRANTY CLAIM OR CLAIMS.

No other terms, conditions, understanding, or agreements purporting to modify the terms of this warranty shall have any legal effect unless made in writing and signed by a corporate officer of the Seller.

1555 McCandless Drive, Milpitas, CA 95035 Tel: (800) 726-3364 / (408) 263-5333 Fax: (408) 263-0119
Fax-on-Demand: (800) 726-7099, press 2 Email: andweighing.com Web: www.andweighing.com